

Profil br. 1
0+000.00

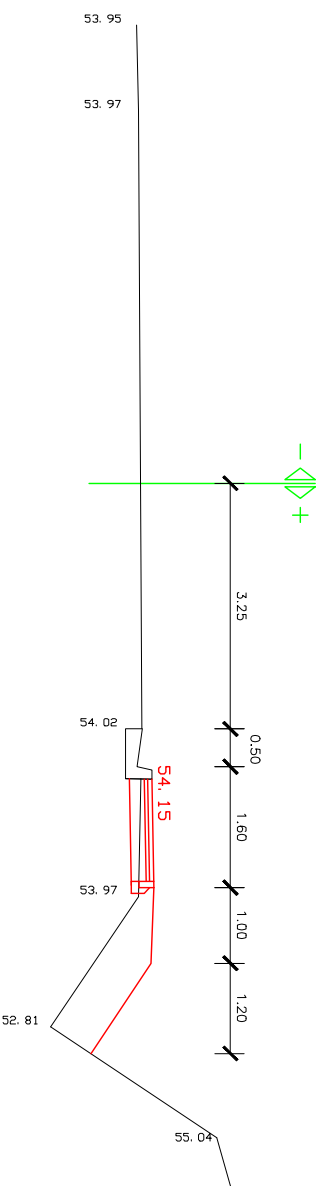

Profil br. 2
0+019.75

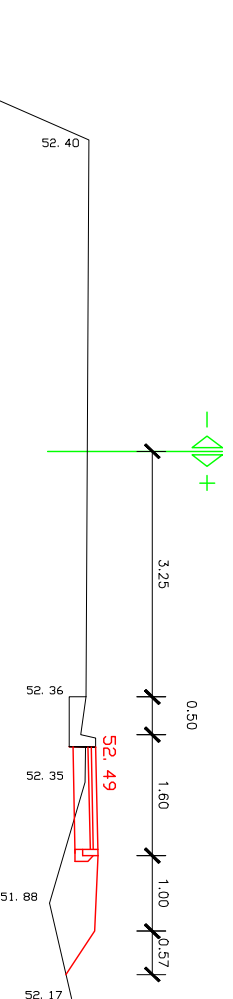

Profil br. 3
0+039.87

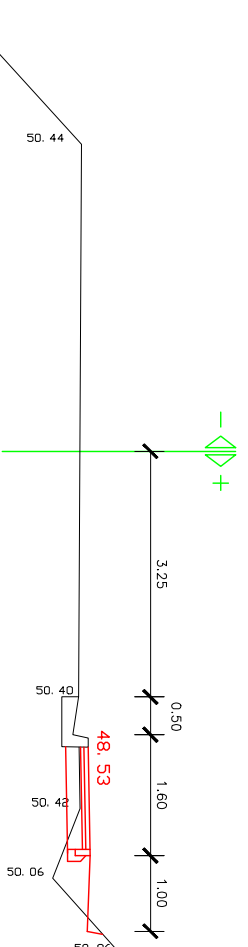

Profil br. 4
0+059.80

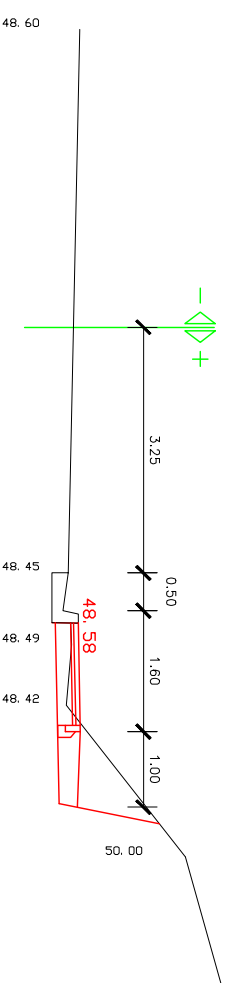

Profil br. 5
0+079.55

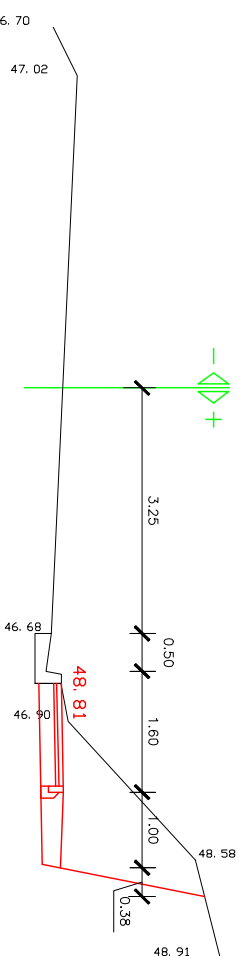

Profil br. 6
0+092.27

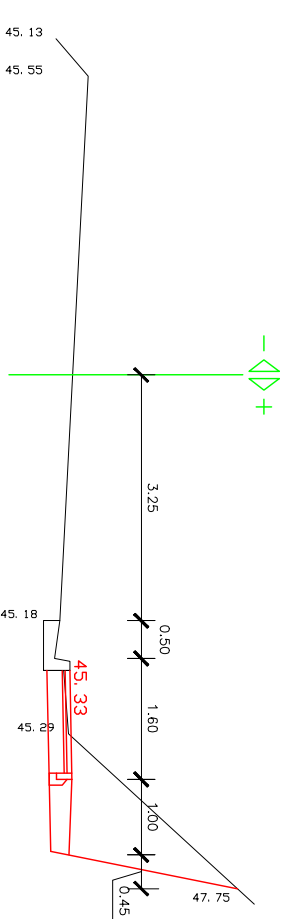

Profil br. 7
0+118.76

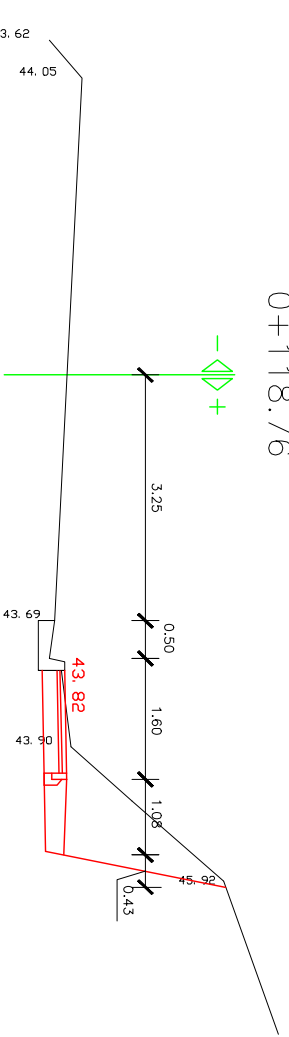

Profil br. 8
1+37.96

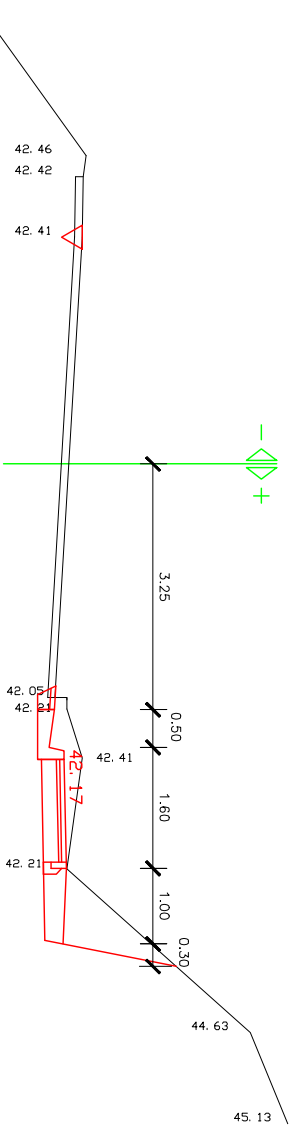

TRASER d.o.o.
za projektiranje i geodeziju
DUBROVNIK - Bračdina 25



INVESTITOR: GRAD KORČULA, Trg A. i S. Radica 1
OBJEKAT: Nogašup pri ulici Antle Starčevića od kružnog toka do raskršćja sa ulicom Korčulanskih domobrana

PROJEKATNA FAZA: GLAVNI PROJEKT

SADRŽAJ: POPREČNI PRESJECI 1-8 M 1:100

PROJEKTANTI: ĐURAN KLEPO dipl.ing.gradj.

SURADNICI: TOMISLAV ĐEKARIN dipl.ing.geod.

MLO LJUBIĆ geod.teh.

DATUM: listopad, 2018 BR.TEHDJN: 84/18 PRILOG BR.: 05-1